



ESPAÑA:
www.miracleplay.com
miracleplay@miracleplay.com
Tel: (+34)913.510.051

PANAMA
www.miracleplaypanama.com
msalom@miracleplay.com
Tel: (+507)6270.3505

www.miracleplay.com / www.miracleplaypanama.com

2019-2020

PARQUES ACUÁTICOS MIRACLE PLAY



www.miracleplay.com / www.miracleplaypanama.com

PARQUES

Acuáticos

En Miracle Play nos hemos propuesto combinar la tecnología y el diseño con la diversión para crear grandes y novedosos proyectos de parques acuáticos.

Los parques de agua Miracle Play son innovadores en sus diseños y están fabricados con materiales de alta calidad y resistencia. Realizamos proyectos individuales y personalizados para cada cliente. Además, contamos con **personal cualificado** para diseño y la construcción de estas instalaciones.

Los conjuntos y los diversos elementos acuáticos de Miracle Play están especialmente pensados para Hoteles, Clubs Deportivos, Piscinas Públicas, Parques Acuáticos, etc. y abarcan desde toboganes de piscina, piscina hasta chapoteo

Ponemos a su servicio la **experiencia y la asesoría profesional** que ofrecemos a nuestros clientes.

En este catálogo encontrará:

- TOBOGANES ACUÁTICOS
- PISCINAS DE CHAPOTEO
- CONJUNTOS DE POLIETILENO



Diseñamos a medida para ofrecer a cada cliente un proyecto que marque la diferencia y se adapte al volumen y necesidades de su hotel o parque acuático.

El diseño de cada proyecto se puede dividir en 4 partes.

1- Recepción de nuestros clientes

Como primer contacto con el proyecto escuchamos las ideas de nuestros clientes y aconsejamos sobre los toboganes ideales para su espacio, teniendo en cuenta la capacidad de las instalaciones, diseño y presupuesto.

2- Diseño por ordenador.

Como primera etapa diseñamos una propuesta inicial que permita al cliente visualizar la idea del proyecto. Una vez realizada una primera aprobación del proyecto, combinamos los métodos y tecnologías más actuales y realizamos los planos de los proyectos en 3d de todos los toboganes acuáticos, para así comprobar su desarrollo y su buen funcionamiento. Éste tipo de planos e imágenes son la herramienta perfecta de marketing ,ya que permite a nuestros clientes una visualización total de la obra que pueden vender a sus clientes o tour operadores incluso antes de que el parque acuático sea construido.

3- Etapa de ejecución.

En esta fase del proyecto nuestro trabajo consiste en aportar todos los cálculos generales, cimentaciones, soportes y estructuras que soportan los toboganes acuáticos para así dar inicio a su construcción.

4- Certificación para su uso.

Miracle Play una vez finalizada la obra, prueba y garantiza el perfecto funcionamiento de la misma para que así, nuestros clientes y usuarios puedan tener el pleno disfrute de las instalaciones con la mayor seguridad.



TOBOGANES ACUÁTICOS

TORRE DE TOBOGANES

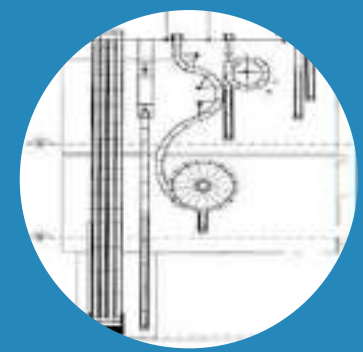

DISEÑO

+



INSTALACIÓN

+



DISFRUTE

Miracle Play cuenta con una amplia gama de toboganes de agua que te permiten diseñar torres de toboganes adaptadas al área que dispongas, desde pequeña hasta una gran escala. Los toboganes pueden llegar a una piscina así como también disponer de canal de frenado.

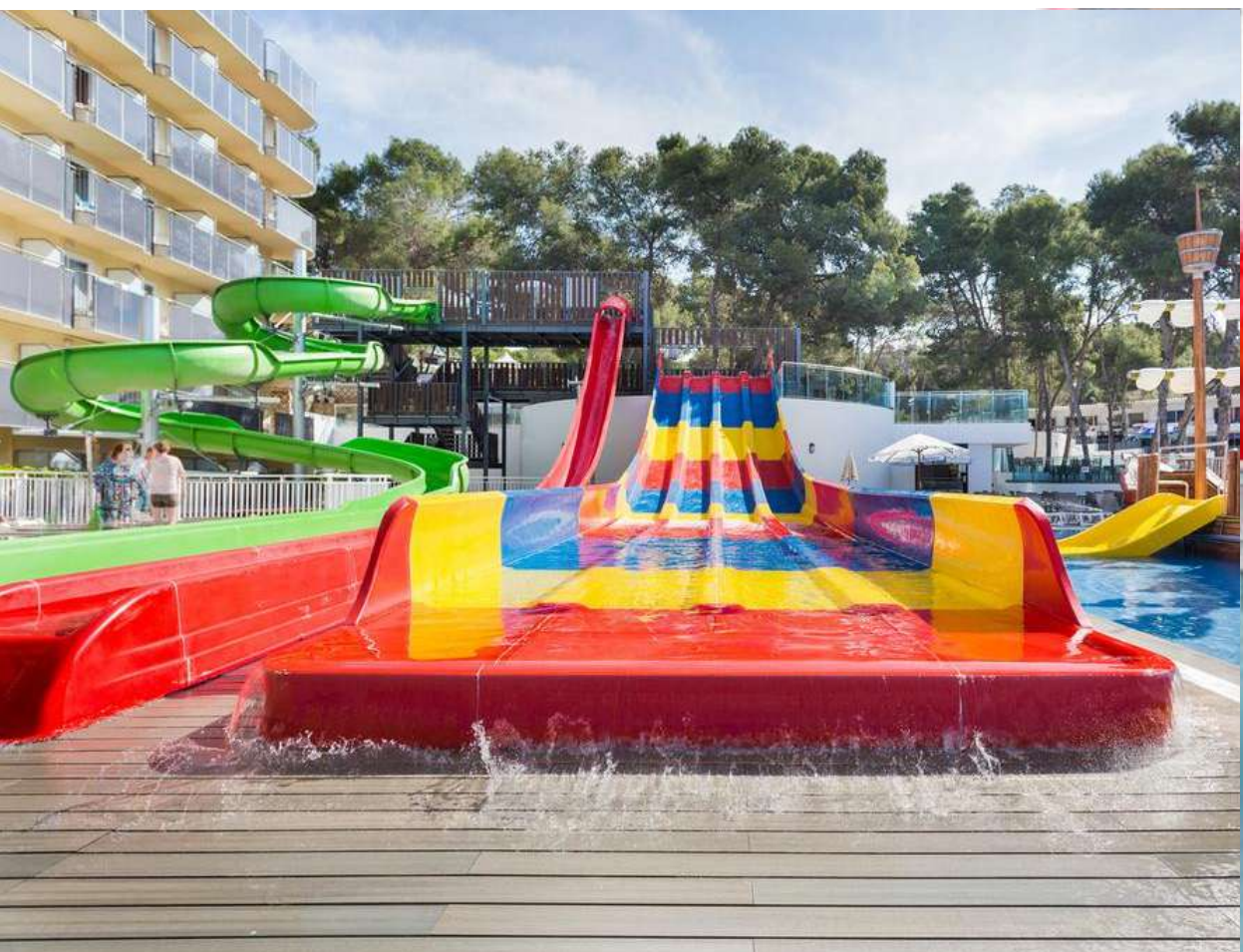

PARTES QUE COMPONEN LA TORRE DE TOBOGANES

COLORES FIBRA DE VIDRIO



PLATAFORMA DE SALIDA
FABRICADA EN FIBRA DE VIDRIO

MP-A19007



DESARROLLO DEL
TOBOGÁN



ESTRUCTURA ACERO GALVANIZADO

	VERDE	RAL 6018		BEIGE	RAL 1015
	AZUL	RAL 5017		AMARILLO AZAFRÁN	RAL 1017
	AZUL PASTEL	RAL 5024		AMARILLO	RAL 1023
	VERDE CORAL	RAL 6027		NARANJA	RAL 2011
	VERDE BOSQUE	RAL 6029		ROJO	RAL 3000
	GRIS	RAL 7040		FUCSIA	RAL 9006
	MARRÓN	RAL 8024		AZUL MARINO	RAL 5003
	BLANCO	RAL 9003		AZUL CIELO	RAL 5012
	NEGRO	RAL 9017			



CANAL DE FRENADO

TIPOLOGÍA TOBOGANES



TOBOGÁN MULTIPISTA

MP-A19001

- Ancho: 0.95 m por pista.
- Caudal: 12 l/s por pista.
- Tipo: Cuerpo- 1 persona por pista- inclinación media máxima de entre el 20% y el 40%, excluyendo la zona de llegada

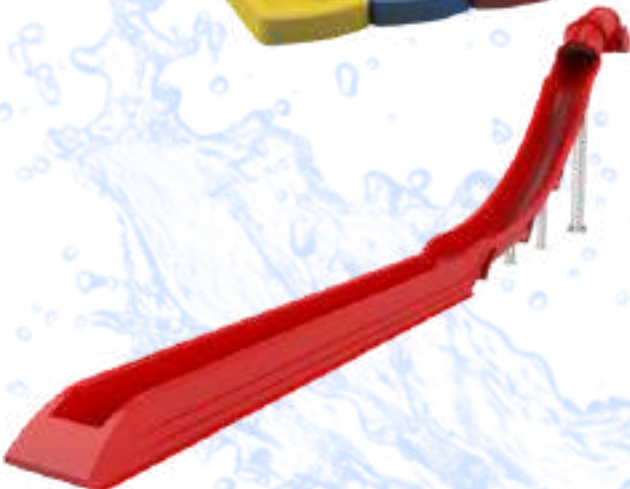

TOBOGÁN STUKA

MP-A19002

- Ancho: 0.95 m .
- Caudal: 15 l/s .
- Tipo: Cuerpo- 1 persona en uso- inclinación media máxima de 20%, excluyendo la zona de llegada



TOBOGÁN ESPIRAL ABIERTO

MP-A19003

- Medidas: 0.95 m por pista.
- Caudal: 15 l/s.
- Tipo: Cuerpo- 1 persona en uso- inclinación media máxima de entre el 13% y el 18%, excluyendo la zona de llegada



TOBOGÁN VORTEX

MP-A19004

- Ancho: 0.95 m .
- Caudal: 18 l/s .
- Tipo: Cuerpo- 1 persona en uso- inclinación media máxima de 13%, excluyendo la zona de llegada- desde un Tobogán a otro.



TOBOGÁN KAMIKAZE

MP-A19005

- Ancho: 0.95 m.
- Caudal: 12 l/s por pista.
- Tipo: Cuerpo- 1 persona por pista- inclinación media máxima 16 %, excluyendo la zona de llegada

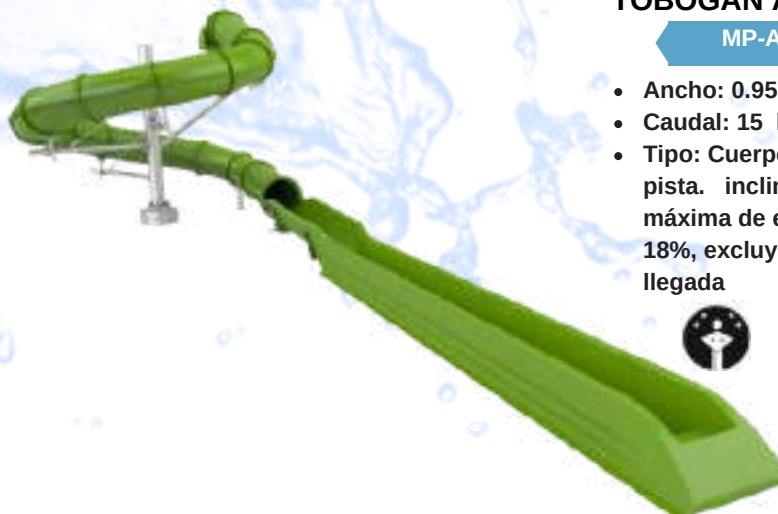

TOBOGÁN AQUATUBO 32"

MP-A19006

- Ancho: 0.95 m.
- Caudal: 15 l/s por pista.
- Tipo: Cuerpo- 1 persona por pista. inclinación media máxima de entre el 13% y el 18%, excluyendo la zona de llegada



TORRE DE TOBOGANES

DISEÑOS

MP-A19008

TIPOS DE TOBOGANES

- (A) TOBOGÁN MULTIPISTA 4 CARRILES
- (B) TOBOGÁN KAMIKAZE
- (C) TOBOGÁN VORTEX
- (D) AQUATUBO 32"
- (E) TOBOGÁN STUKA
- (F) TOBOGÁN ESPIRAL ABIERTO

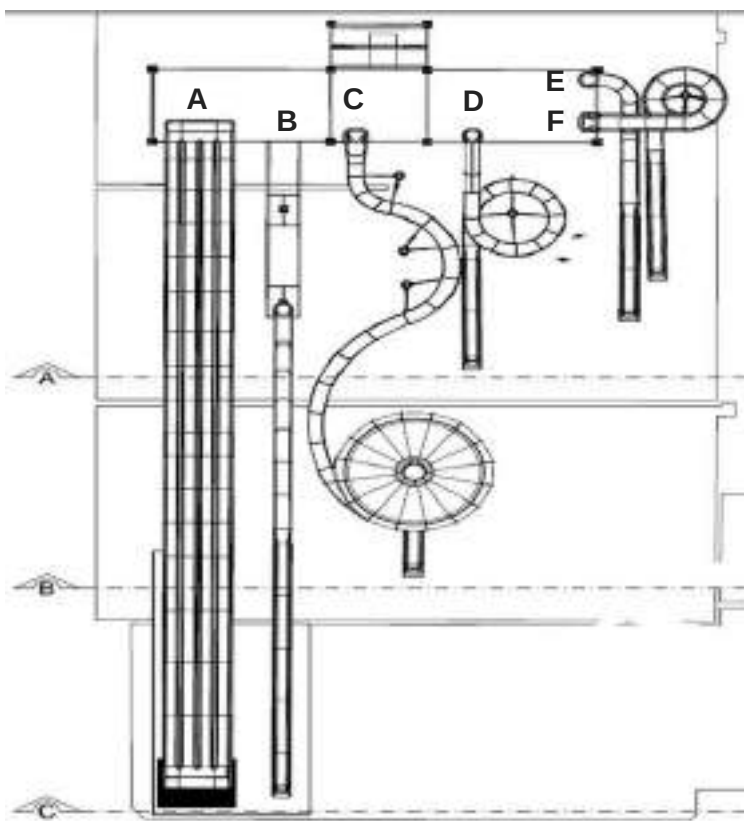

PLANTA DE TOBOGANES





RENDER



FOTOGRAFÍA

MP-A19009

- - (A) AQUATUBO 32" 6.00m
- - (B) TOBOGÁN STUKA 6.00m
- - (C) TOBOGÁN MULTIPUSTA 4 CARRILES 6.00m

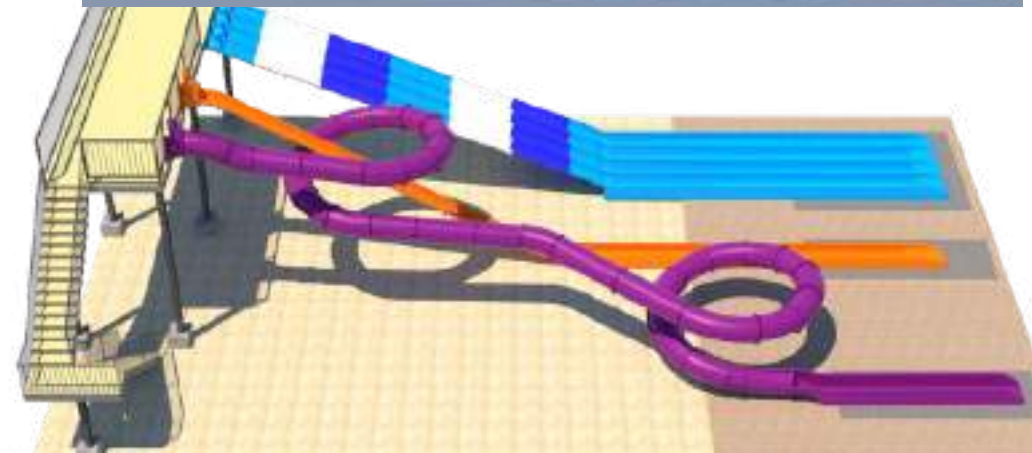
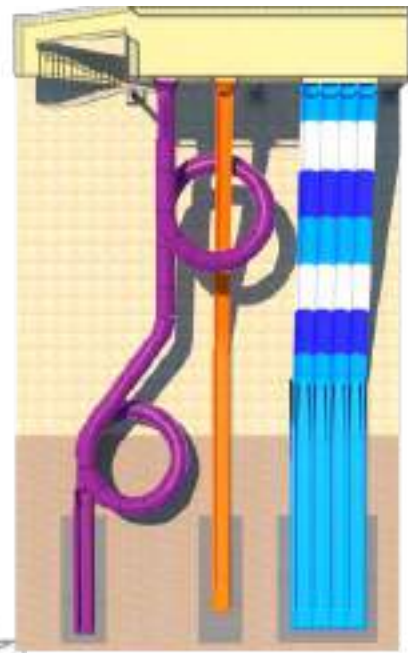
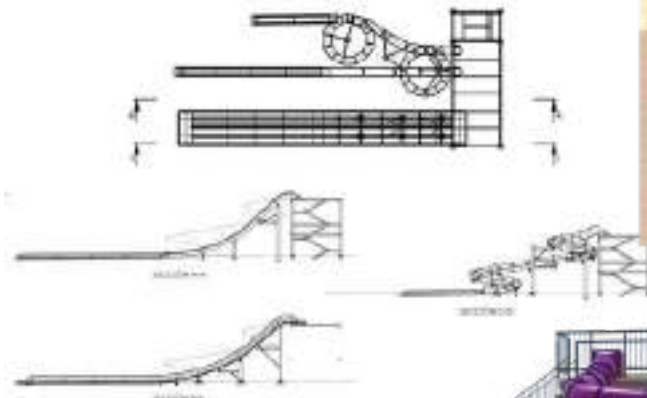

MP-A19010

- - (A) AQUATUBO 32" 3.80m



TORRE DE TOBOGANES ADAPTADOS

Diseñamos tus toboganes en el espacio que dispongas, brindándole a tu hotel rincones de diversión.

MP-A19011

- (A) AQUATUBO 32" 7.00m
- (B) TOBOGÁN ESPIRAL ABIERTO 7.00m

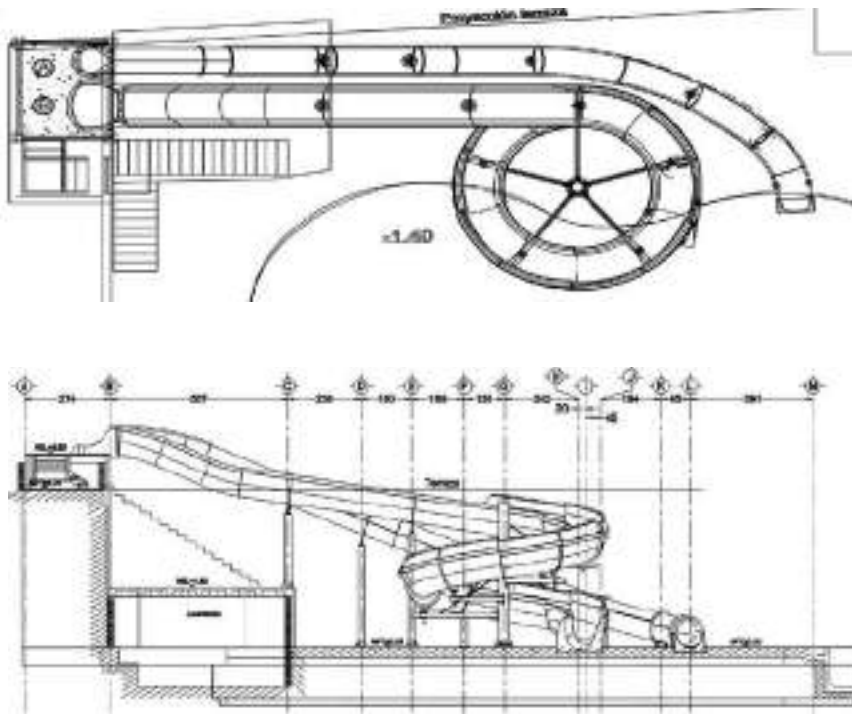

MP-A19012

- - (A) AQUATUBO 32" 4.50m
- - (B) AQUATUBO 32" 4.50m



La Jardinera o áreas verdes de tu espacio pueden ser el lugar ideal para que incorpores una torre de toboganes para tu piscina.



- Incorpora estructura de plataforma de salida fabricada en Fibra de vidrio y tornillería en acero con calidad marina.



MP-A19013

- (A) TOBOGÁN MULTIPISTA 4 CARRILES 4.50m
- (B) TOBOGÁN STUKA 6.80m
- (C) TOBOGÁN ESPIRAL ABIERTO 6.80m

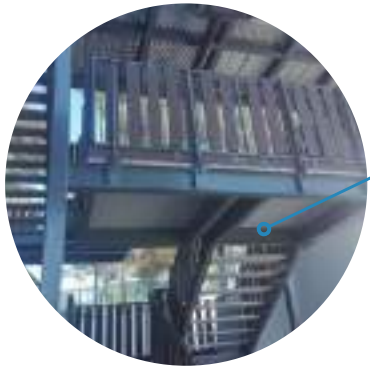

- Incorpora estructura de plataforma de salida fabricada con perfiles de acero.

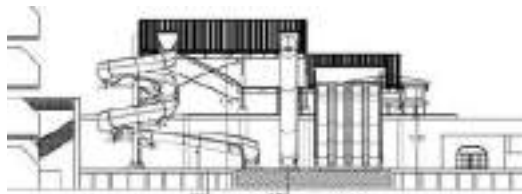

RENDER



FOTOGRAFÍA

- - (A) TOBOGÁN MULTIPISTA 4 CARRILES 8.00 m
- - (B) TOBOGÁN STUKA 8.00 m
- - (C) TOBOGÁN ESPIRAL ABIERTO 8.00 m
- - (D) AQUATUBO 32" 8.00m

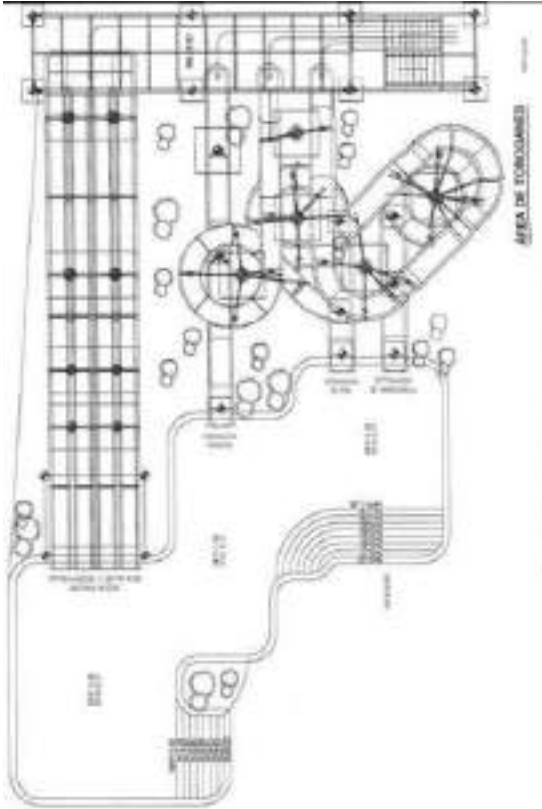

MP-A19015

- - (A) TOBOGÁN RECTO 1.8 m
- - (B) TOBOGÁN STUKA 2.80 m
- - (C) AQUATUBO 32" 3.00m



MP-A19016

- - (A) TOBOGÁN EXTRA ANCHO 1.50 m

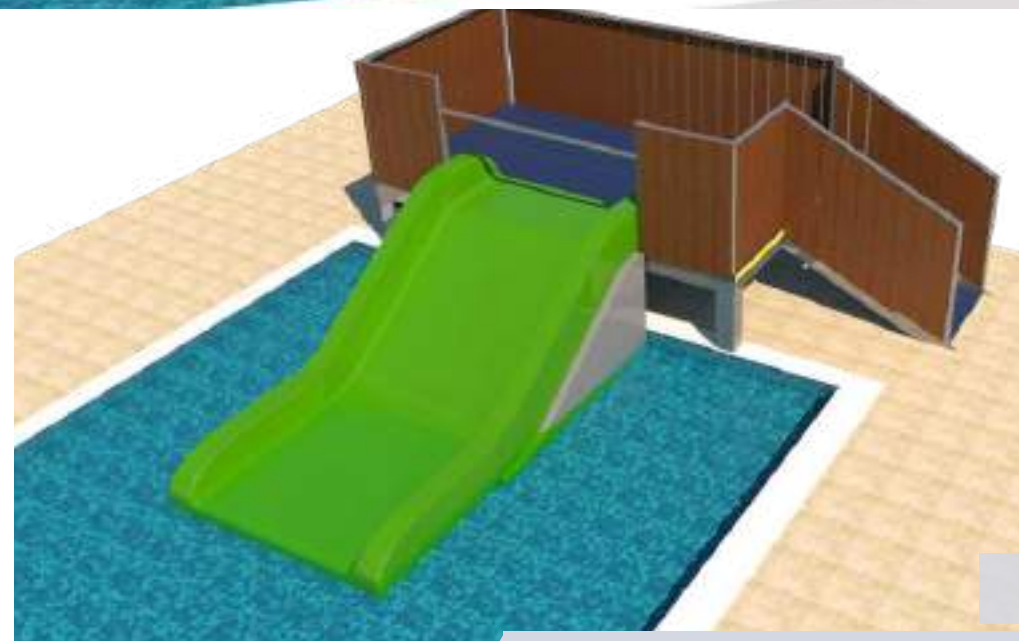

PISCINAS DE CHAPOTEO

PISCINAS TEMATIZADAS INFANTILES



DISEÑO

+



INSTALACIÓN

+



DISFRUTE

Las piscinas infantiles de Miracle Play son espacios acuáticos de entretenimiento pensadas para niños. La profundidad de estas piscinas es de entre 30 a 45 cm. Son divertidas, seguras y se pueden personalizar según las necesidades de cada cliente.





JUEGOS PISCINA CHAPOTEO



MP-A19017

- **Medidas:** 800 x 450 x 450 cm
- **Material:** Fibra de vidrio
- **Edad:** 3-12 años

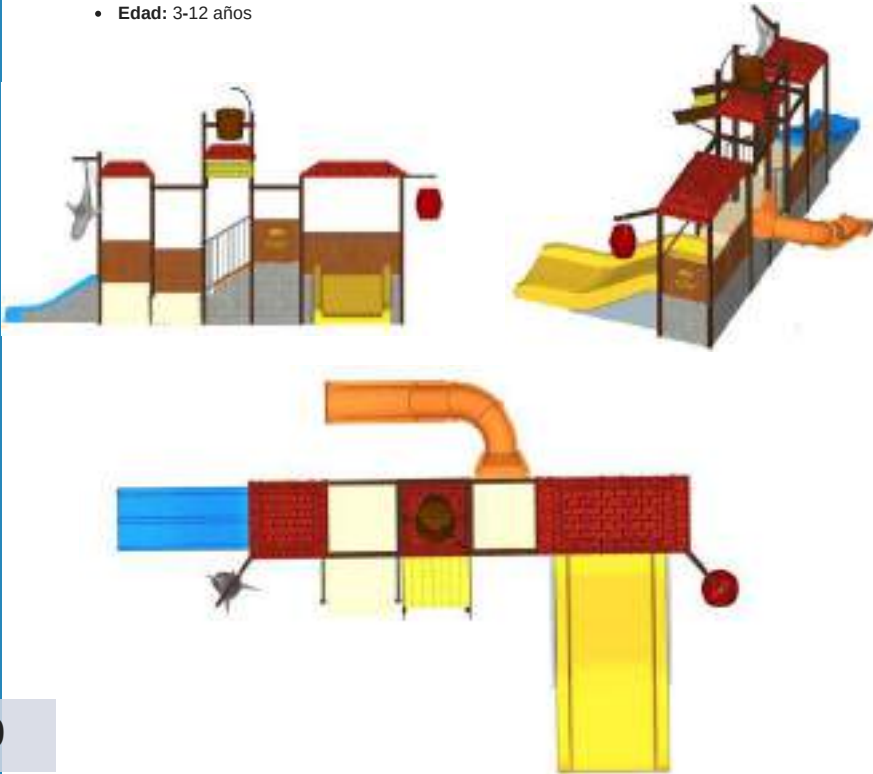

MP-A19018

- **Medidas:** 545 x 545 x 450 cm
- **Material:** Fibra de vidrio
- **Edad:** 3-12 años

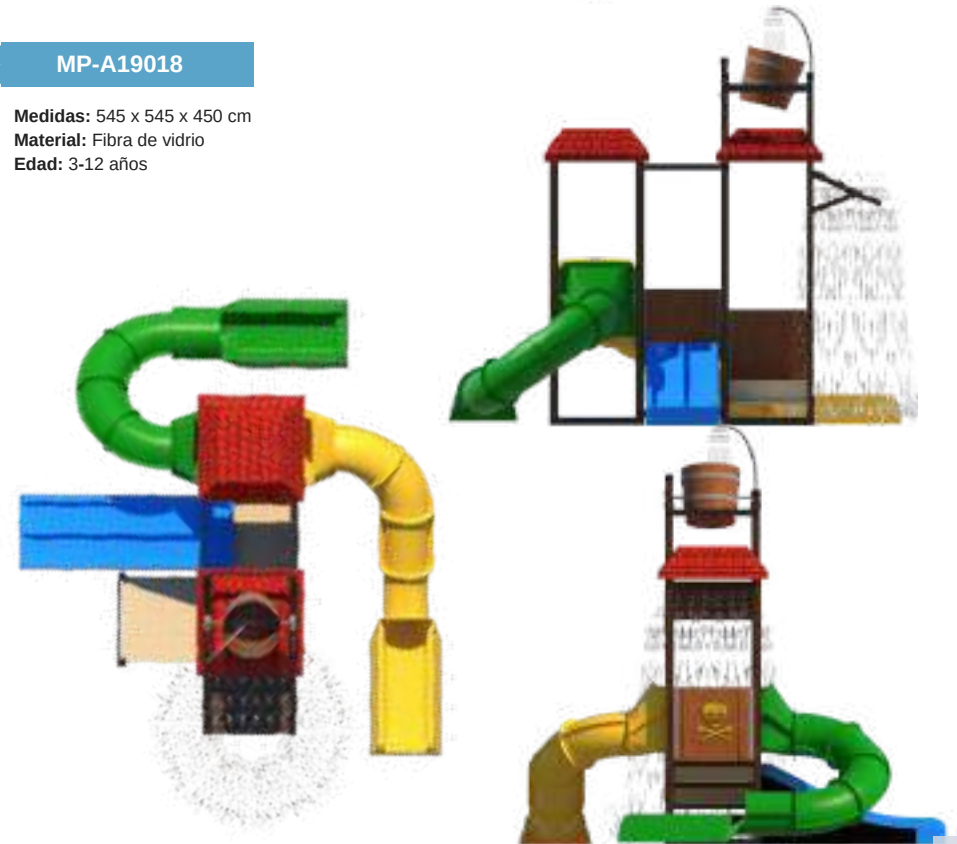



PISTOLA DE AGUA

MP-A19019

- Medidas: 50x60x130 cm
- Material: Acero

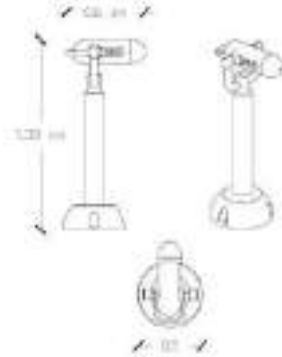

CUBETAS

MP-A19020

- Medidas: 215m
- Material: Acero

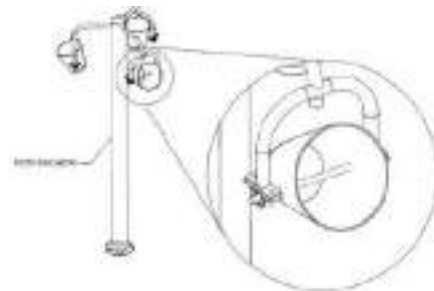

BARRIL VOLCADOR

MP-A19021

- Medidas: 150x 150x 350cm
- Material: Fibra de vidrio

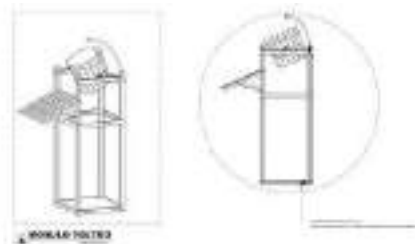

MP-A19022

- Medidas: 350x600x450cm
- Material: Fibra de vidrio



MP-A19023

- Medidas: 600x 450 x450cm
- Material: Fibra de vidrio





DUMPING BARREL

La mejor opción para piscinas pequeñas y medianas. Incorpora varios toboganes para los niños y un divertido barril que se va llenando y se vacía en el momento menos esperado.

MP-A19024

- **Medidas:** 460x 370x 450 cm
- **Material:** Fibra de vidrio

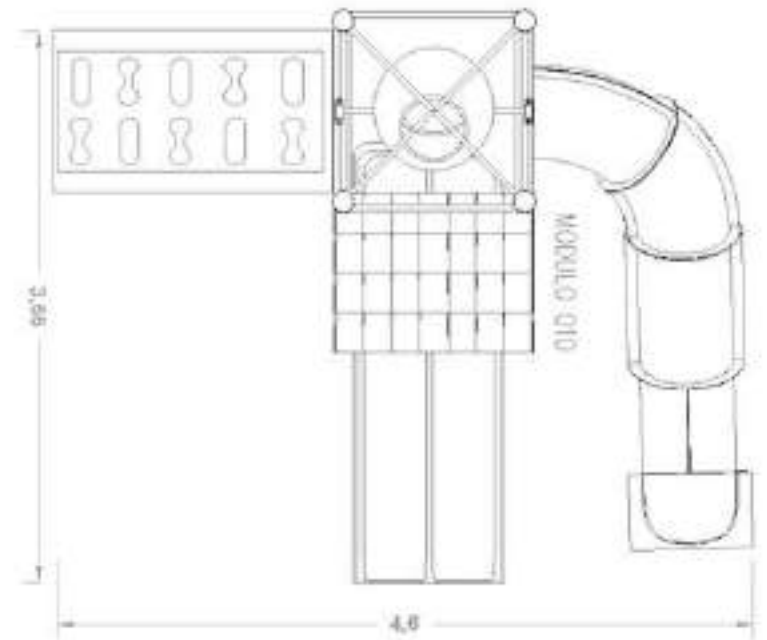



MODULO FORTALEZA

MP-A19025

- Medidas: 600x300x450cm
- Material: Fibra de vidrio

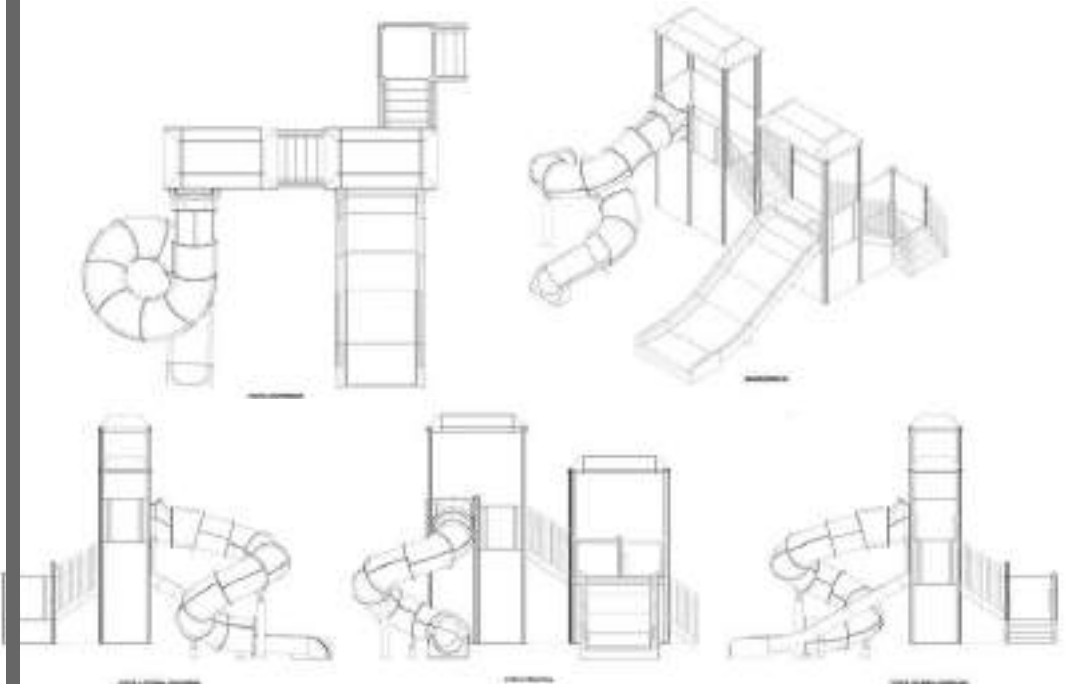

BARCO PIRATA ESTANDAR



MP-A19026

- Medidas: 800x500x450cm
- Material: Fibra de vidrio

MP-A19027

- Medidas: 650x500x450cm
- Material: Fibra de vidrio







BARCO PIRATA

MAXI

MP-A19028

- Medidas: 980x500x450cm
- Material: Fibra de vidrio





POLINESIA

MULTIJUEGO



MP-A19028

El conjunto Polinesia es ideal para incorporar en una sola piscina de chapoteo desde toboganes de gran escala hasta toboganes pequeños donde pueda disfrutar toda la familia.



HAWAII

MODULO + TORRE DE TOBOGANES



MP-A19029

- Medidas: 1100 x 800 x 450 cm
- Material: Fibra de vidrio

MP-A19030

- - (A) AQUATUBO 32" 3.00m
- - (B) TOBOGÁN MULTIPISTA

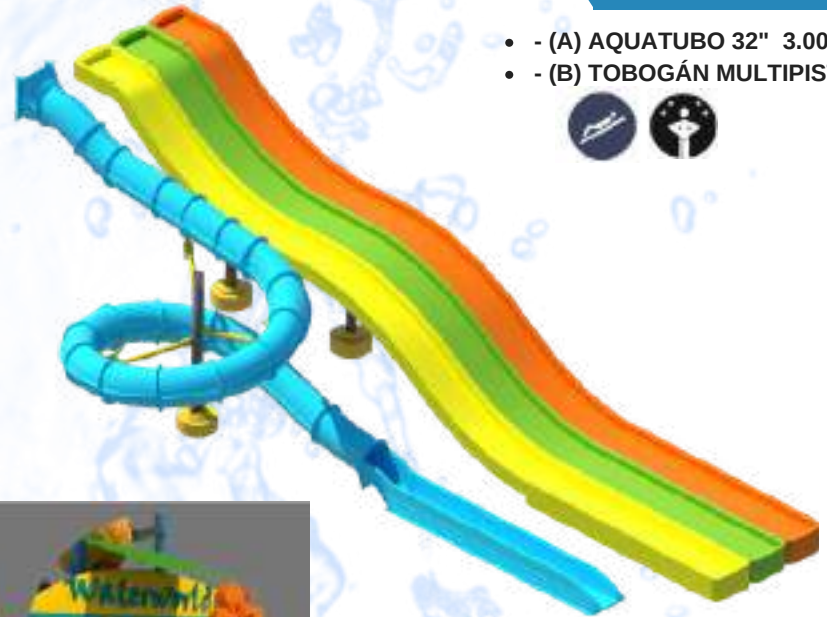



MODULO

SAFARI

Módulo con tematización safari que incorpora distintas plataformas de las cuales salen toboganes a diferentes alturas. Sus barriles volcadores añaden diversión en el área de piscina.

MP-A19031

- **Medidas:** 1900 x 950 x 800 cm
- **Material:** Fibra de vidrio

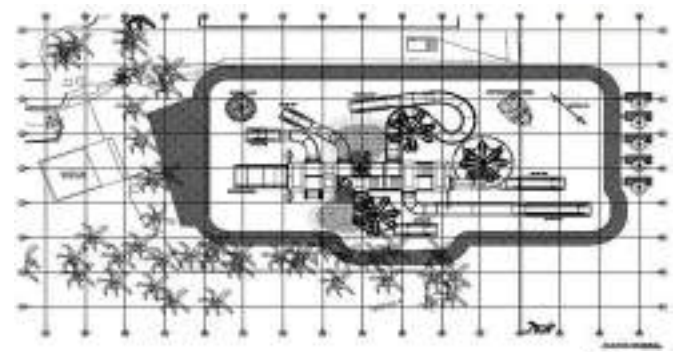



DISEÑAMOS TU PISCINA

Incorporando módulo y componentes en tu piscina chapoteo te permite crear un área idónea para toda la familia con una gran calidad visual y divertida.

MP-A19032

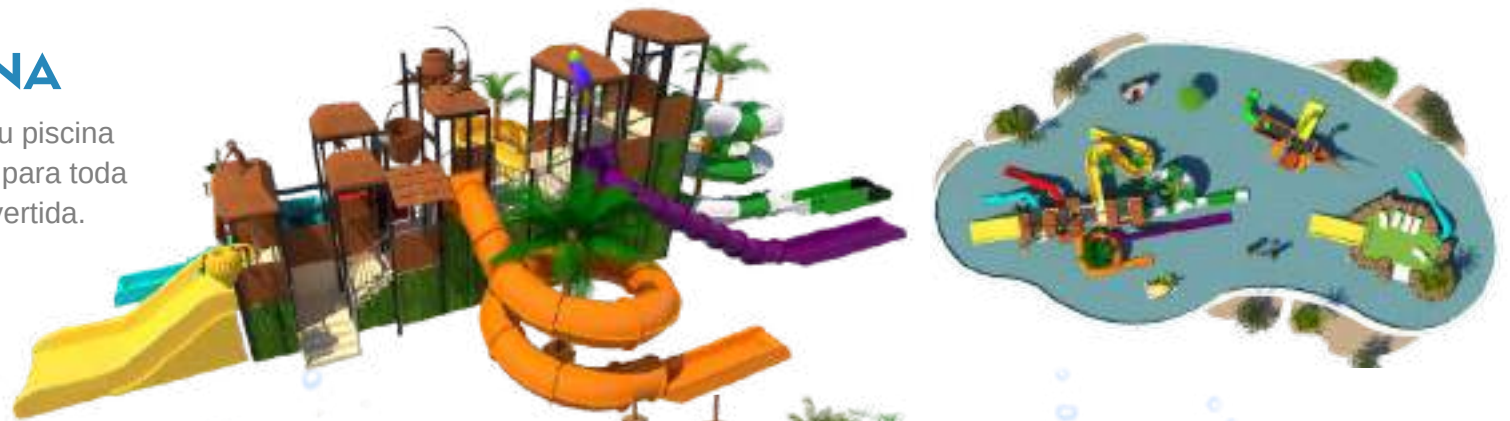

TROPICAL MODULO

MP-19033



MP-A19034







MP-A19036



MP-A19037

- **Medidas:** 3,13 x 1,62 x 2,41 m
- **Material:** Fibra de vidrio
- **Edad :** 3-12 años



MP-A19038

- **Medidas:** 2,75 x 2,01 x 1,97 m
- **Material:** Fibra de vidrio
- **Edad:** 3-12 años



MP-A19039

- **Medidas:** 268 x 440 x 330 m
- **Material:** Fibra de vidrio
- **Edad:** 3-12 años

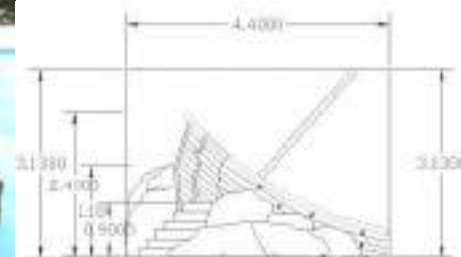

MP-A19040

- **Medidas:** 2,50 x 2,00 m
- **Material:** Fibra de vidrio
- **Edad:** 3-12 años

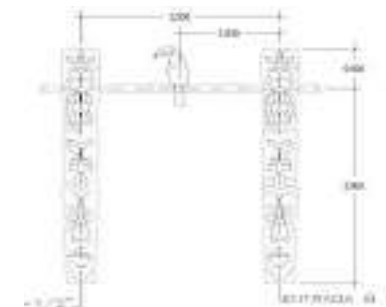

MP-A19041

- **Medidas :** Diametro: 2,44m Altura: 3,01m
- **Material:** Fibra de vidrio
- **Edad :** 3-12 años

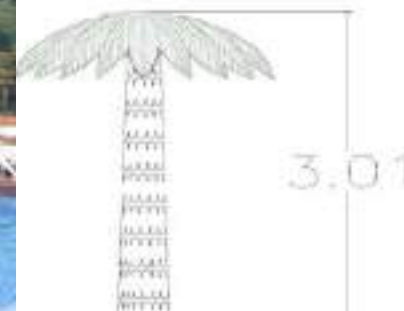

CONJUNTOS

POLIETILENO PARA PISCINA

Ideal para una rápida y más económica instalación con el mismo nivel de diversión y durabilidad.

MP-A19042

- **Medidas:** 900 x 500 X 450 cm
- **Material:** Polietileno rotomoldeado







BARCO PIRATA

POLIETILENO

MP-A19043

- Medidas: 1400 x 600 X 800 cm
- Material: Polietileno rotomoldeado



MP-A19044

- Medidas: 900 x 600 X 450 cm
- Material: Polietileno rotomoldeado



MP-A19045

- Medidas: 1100 x 600 X 600 cm
- Material: Polietileno rotomoldeado



MP-A19045 B

- Medidas: 900 x 600 X 500 cm
- Material: Polietileno rotomoldeado



MP-A19046

- **Medidas:** 320 x 250 X 300 cm
- **Material:** Polietileno rotomoldeado



MP-A19047

- **Medidas:** 450 x 450 X 350 cm
- **Material:** Polietileno rotomoldeado

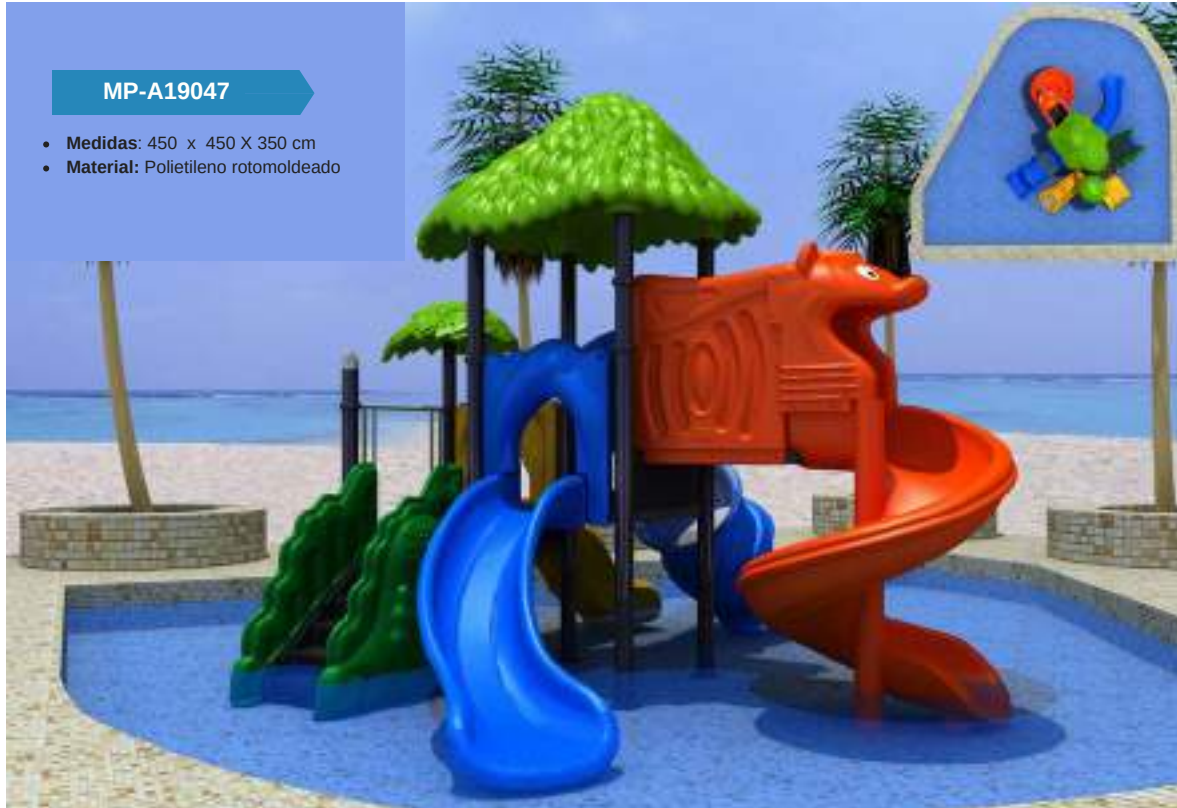

MP-A19048

- **Medidas:** 350 x 450 X 600 cm
- **Material:** Polietileno rotomoldeado



MP-A19049

- Medidas: 750 x 450 X 600 cm
- Material: Polietileno rotomoldeado



MP-A19050

- Medidas: 350 x 600 X 700 cm
- Material: Polietileno rotomoldeado

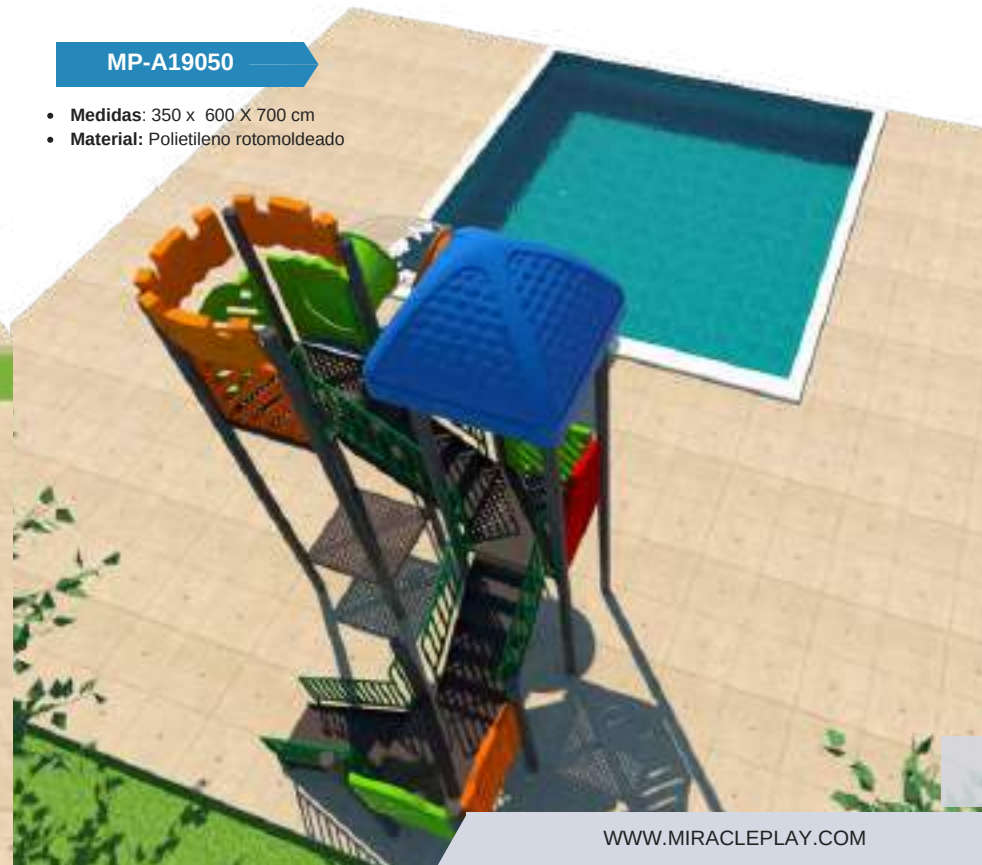





Con más de 2000 instalaciones en espacios públicos, comerciales y de entretenimiento en mas de 10 países, MIRACLE PLAY SL. es el líder en entretenimiento acuático. Brindamos soluciones y juegos acuáticos de alta calidad que crean recuerdos inolvidables. Nuestra misión es continuar desarrollando productos divertidos, seguros y fiables para toda la familia.